

894 Series

Sanitary Valves

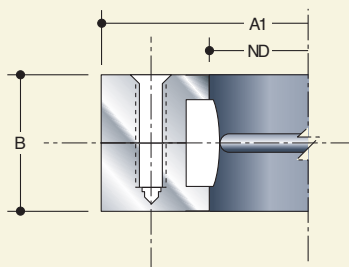

Completely interchangeable with Cora Valves

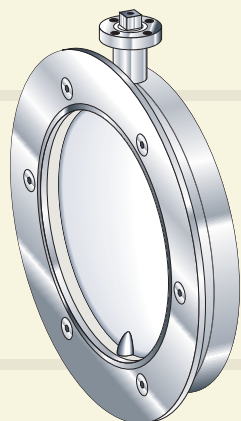
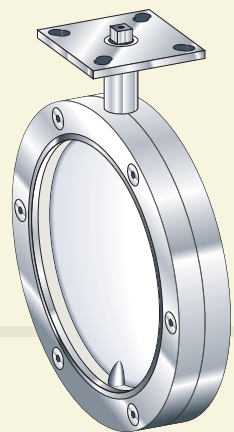

Model: Wafer (WAF)
Sizes Available: 4" thru 16"

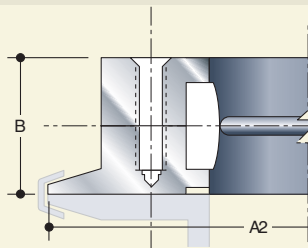
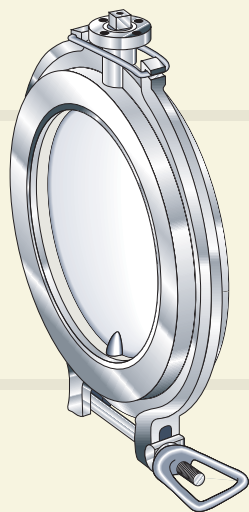
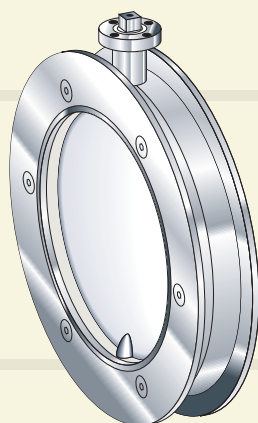

Model: Wafer - Quick Release (WQR)
Sizes Available: 4" thru 16"

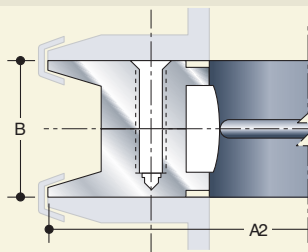
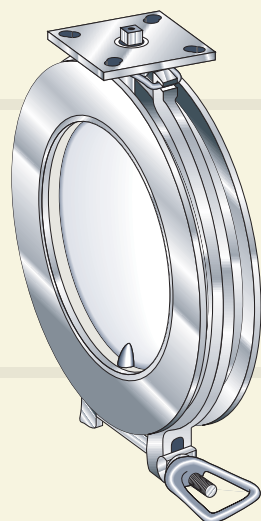
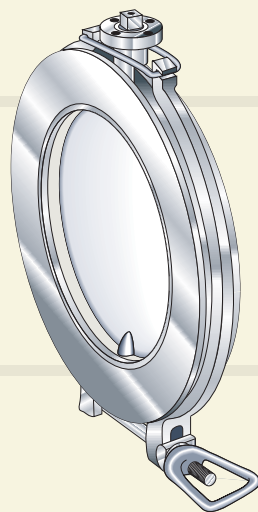

Model: Quick Release - Quick Release (QRQR)
Sizes Available: 4" thru 16"

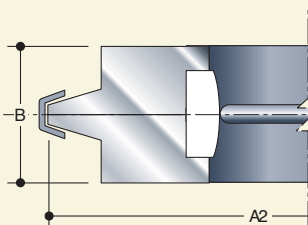

Model: Wafer, Quick Clean (WQC)
Sizes Available: 4" thru 16"

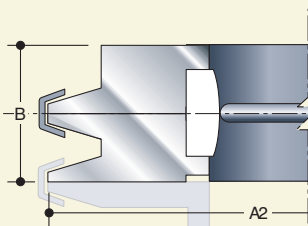

Model: Wafer, Quick Clean - Quick Release (QCQR)
Sizes Available: 4" thru 16"

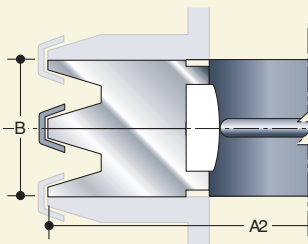

Model: Quick Release, Quick Clean (QRQC)
Sizes Available: 4" thru 16"

ND=NOMINAL DIAMETER

Half Bodies

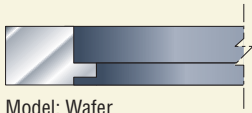

Model: Wafer
Type: BW



Model: Quick Release
Type: QR

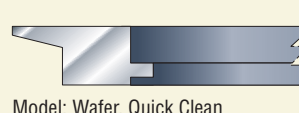

Model: Wafer, Quick Clean
Type: WC

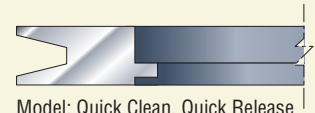

Model: Quick Clean, Quick Release
Type: RC

Valve Types

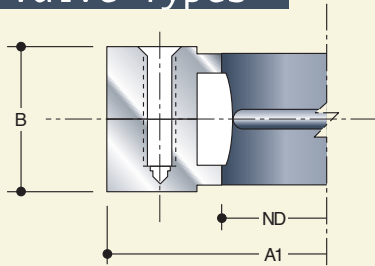

Model: Wafer
Type: WAF

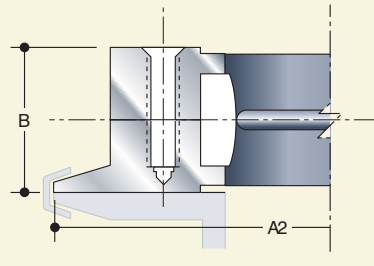

Model: Wafer - Quick Release
Type: WQR

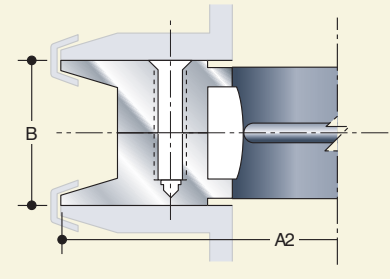

Model: Quick Release - Quick Release
Type: QRQR

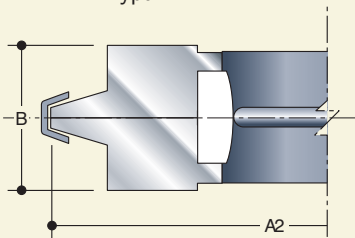

Model: Wafer - Quick Clean
Type: WQC

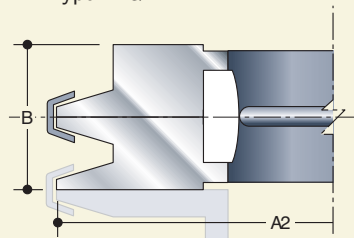

Model: Wafer, Quick Clean - Quick Release
Type: QCQR

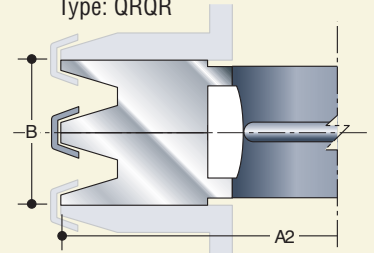

Model: Quick Release - Quick Clean
Type: QRQC

ND=NOMINAL DIAMETER

Accessories

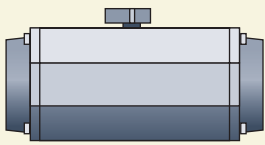

Model: Double Acting Actuator, Pneumatic or Spring Return
Type: DA; SR

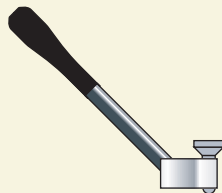

Model: Hand Lever with Locking Pin
Type: L



Model: Clamp Band
Type: B



Model: Blanking Plate
Type: P

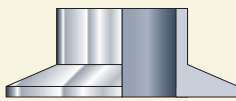

Model: Mounting Flange
Type: MF

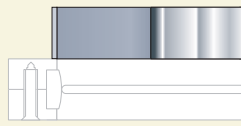

Model: Welding Spigot
Type: S

Ordering

When ordering please use the "Type" code to identify valve parts, ie. BW, QR, QRQR... or accessories ie. L, DA, SR, MF...

Standard valve is polished AISI 316 stainless steel, half valves and accessories are satin finished stainless steel AISI 316.

A typical valve order would consist of:

1 Sure Seal Sanitary Valve

Nominal Diameter: 8" (200mm)

Type: Quick Clean, Half Body Wafer - Half Body with quick release end.

Accessories: Welded Outlet Spigot to half body wafer, mounting flange and clamp band to half body with quick release end. Double acting Pneumatic Actuator.

Material: Butterfly-AISI 316; Body-AISI 316.

Finish: Butterfly Polished; Body Polished

Qty.	Style	Type	Accessories	Actuator
1	894 Series	QCQR	S-MF-B	DA
Material	Finish			
Butterfly 316	Body 316	Butterfly Polished	Body Polished	

Quick Clean valves include clamp for joining half bodies.

Clamp bands are universal for quick clean and quick release applications.

Actuation

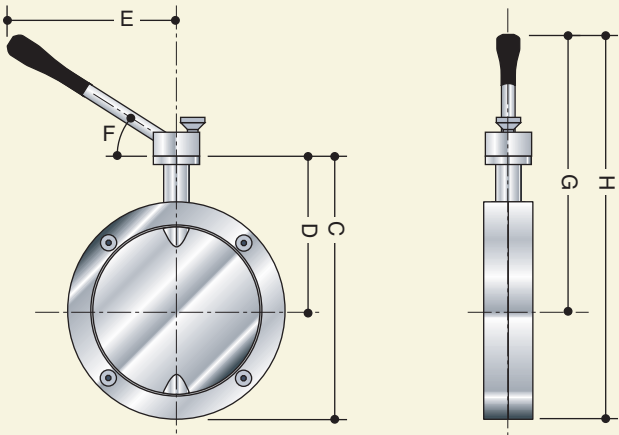

Stainless Steel handle features self locking mechanism in numerous positions.

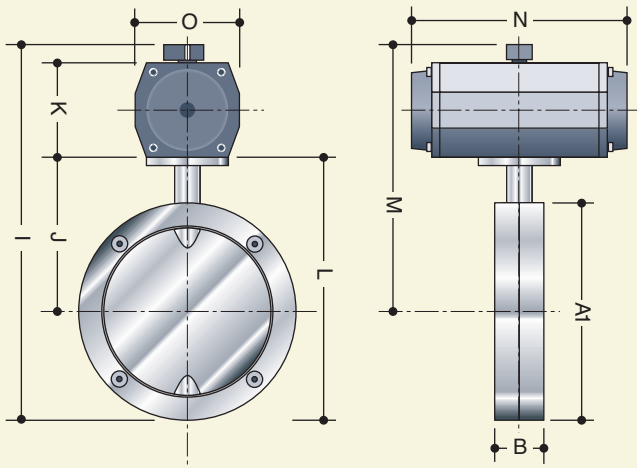

Double acting pneumatic or spring return actuator, stainless steel available

Pneumatic actuators require a minimum of 4 bar or 58 psi

CAM positioner available

Drive systems and modifications available

Removable actuation systems (automatic actuation systems)

Features

Electropolished finish for best surface cleanliness and minimum resistance to flow

Simple to remove and strip for cleaning particularly with quick release version

Minimal size and weight for easy handling

All 316 stainless steel compact parts

Suitable for use with vacuum and pressure

Sterilization by autoclave

Crevice free GMP acceptable design

Ideal for Powders, granules and pastes

Gasket meeting FDA standard

Applications

Loading and unloading of process machinery

Outlet valves for containers for powders, pastes and granules used in the pharmaceutical, food, cosmetics and fine chemicals industries

Sterile air control

Nominal Diameter	Actuator		Valve Body (Kg)						
	PNEU	SR	WAF	WQR	QRQR	WQC	QCQR	QRQC	
4" (100mm)	40DA	103SR	3.5	3.7	3.9	4.3	4.6	5	
6" (150mm)	80DA	200SR	4.8	5.1	5.4	5.8	6.1	6.6	
8" (200mm)	80DA	200SR	6.6	6.9	7.1	7.8	8.2	8.7	
10" (250mm)	80DA	300SR	10	10.2	10.5	11.5	12.1	12.8	
12" (300mm)	80DA	300SR							
14" (350mm)	130DA	500SR							
16" (400mm)	130DA	500SR							

WEIGHTS REFER TO VALVE WITHOUT ACTUATOR

Nominal Diameter	A1	A2	B	C	D	E	F	G	H	I	J	K	L	M	N	O
4" (100mm)	150	180	38	205	130	280	30°	300	375	337	130	100	205	262	162	85
6" (150mm)	200	230	38	255	155	280	30°	350	425	387	155	100	255	287	162	85
8" (200mm)	250	280	38	305	305	280	30°	400	475	437	180	100	305	312	162	85
10" (250mm)	306	330	40	-	-	-	-	-	-	523	213	125	366	370	210	110
12" (300mm)	370	400	40	-	-	-	-	-	-	584	242	125	427	399	210	110
14" (350mm)	420	450	40	-	-	-	-	-	-	633	267	125	477	427	210	110
16" (400mm)	470	500	40	-	-	-	-	-	-	725	292	155	527	527	290	140

ALL DATA SUBJECT TO CHANGE WITHOUT NOTICE



Sanitary Valves

From the heartland of America comes a quality valve for the pharmaceutical and hygiene conscious industries. The Sure Seal 894 Series Butterfly Valve. The 894 offers the greatest value and quality construction available. The 894 is geared to meet a multitude of applications and, with its user friendly design, disassembles in minutes for quick cleaning.

Whether powders, granules or pastes the Sure Seal 894 Series can handle the most demanding situations.

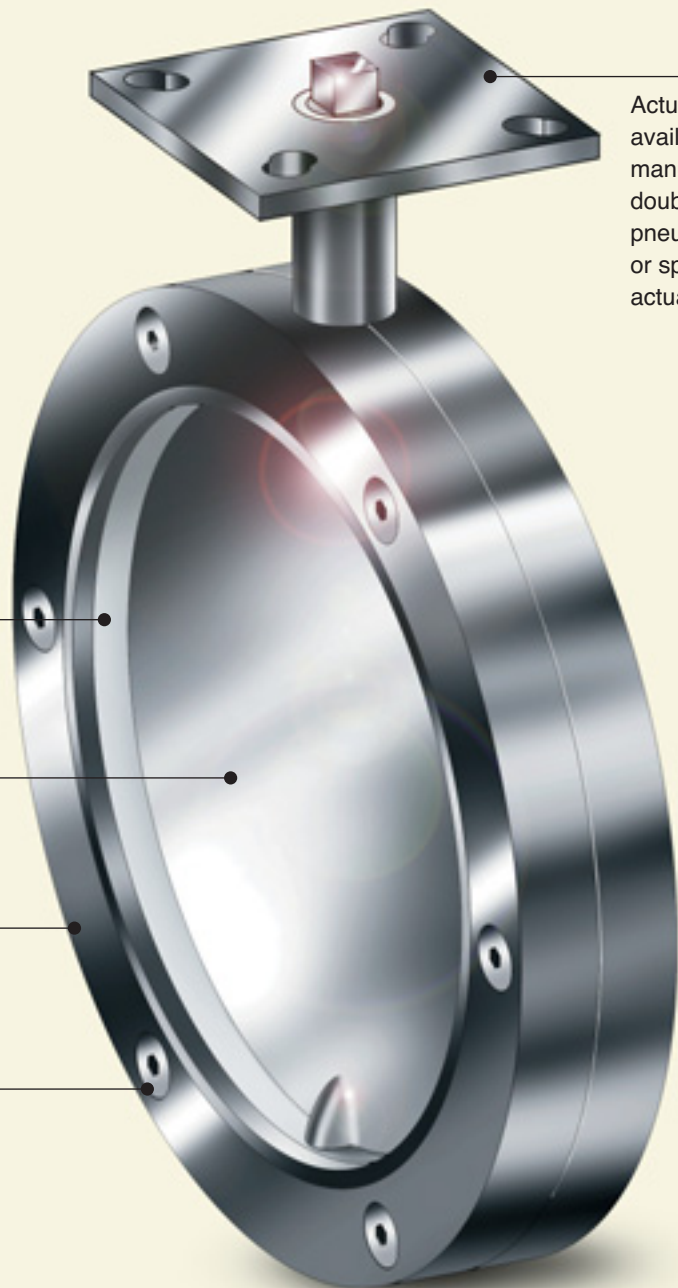

Actuator support available for manual lever, double acting pneumatic or spring return actuators.

Silicone Rubber Standard Seat
other seats for your particular
application available

316 Stainless Steel Disk/Stem
Polished finish for ease of cleaning

316 Stainless Steel housing
available in Polished or Satin finish

316 Stainless Steel Machine Screws

894Series

Item	Description	Material
1	Flat Head Screw	Stainless Steel
2	Knob	Stainless Steel
3	Hand Lever	Stainless Steel
4	Spring	Stainless Steel
5	Plunger	Stainless Steel
6	Bushings	P.T.F.E.
7	Lever Support	Stainless Steel
8	Double Acting Pneumatic or Spring Return Actuator	Anodized Aluminum
9	Actuator Support	Stainless Steel
10	Hexagon Head Screws	Stainless Steel
11	Butterfly	Stainless Steel
12	Seal	Silicone Rubber
13	BW Type Half Body With Blind Threaded Holes	Stainless Steel
14	BW Type Half Body With Through Holes for Screws	Stainless Steel
15	QR Type Half Body With Blind Threaded Holes	Stainless Steel
16	QR Type Half Body With Through Holes for Screws	Stainless Steel
17	WC Half Body	Stainless Steel
18	RC Half Body	Stainless Steel
19	Mounting Flange	Stainless Steel
20	P Type Blanking Plate	Stainless Steel
21	Flat Head Machine Screw	Stainless Steel
22	S Type Outlet Spigot (to be welded to half body)	Stainless Steel
23	B Type Clamp Band	Stainless Steel

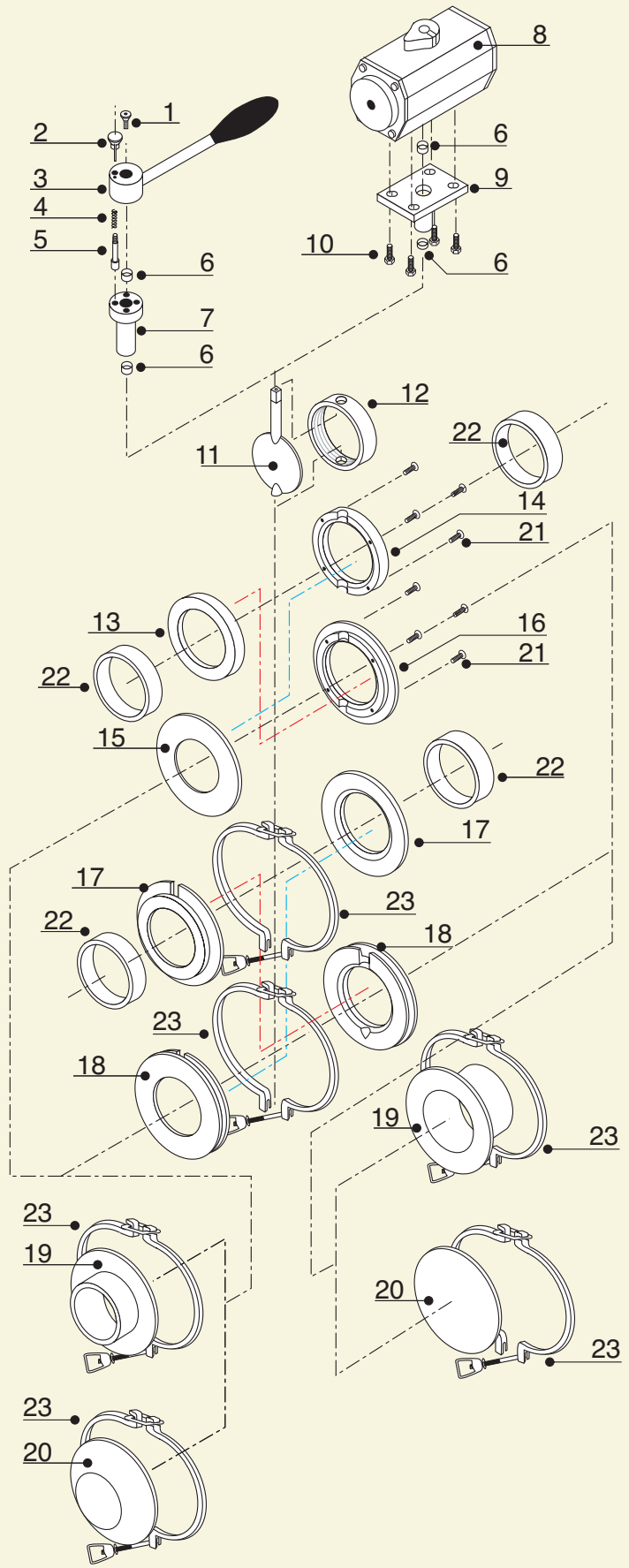

Making a big difference to your bottom line.

Rt. 2, Box 2242 • Mineral Point, Missouri 63660

1-800-382-1604

(573) 438-5000 • Fx (573) 438-4853

The data represented in this brochure is for general information only. Manufacturer is not responsible for acceptability of these products in regard to individual system requirements. For specific performance data and correct materials selection, please contact your Sure Seal Dealer.

©1998 Sure Seal, Incorporated • Printed in USA.